

Cree® P4 LED

Model # LP379THR1-C0G

Data Sheet

120-degree, 7.6 x 7.6 mm LED lamp in high-red color with water-transparent lens and stopper

Applications

- Advertising Signs
- Indicators
- Automotive Lighting

Absolute Maximum Ratings ($T_A = 25^\circ\text{C}$)

Items	Symbol	Absolute Maximum Rating	Unit
Forward Current ^{Note 2}	I_F	70	mA
Peak Forward Current ^{Note 1}	I_{FP}	200	mA
Reverse Voltage	V_R	5	V
Power Dissipation	P_D	220	mW
Operation Temperature	T_{opr}	-40 ~ +100	°C
Storage Temperature	T_{stg}	-40 ~ +100	°C
Lead Soldering Temperature	T_{sol}	Max. 260°C for 3 sec. max. (3 mm from the base of the epoxy bulb)	

Notes:

1. Pulse width ≤ 0.1 msec, duty $\leq 1/10$.
2. A heat sink is recommended if the device is operated at ambient temperatures higher than 25°C.

Typical Electrical & Optical Characteristics ($T_A = 25^\circ\text{C}$)

Characteristics	Symbol	Condition	Unit	Minimum	Typical	Maximum
Forward Voltage	V_F	$I_F = 70$ mA	V		2.6	3.2
Reverse Current	I_R	$V_R = 5$ V	μA			100
Dominant Wavelength	λ_D	$I_F = 70$ mA	nm	620	628	637
Luminous Flux	Φ_V	$I_F = 70$ mA	mlm	3000	4000	
50% Power Angle	$2\theta_{1/2}$	$I_F = 70$ mA	deg		120	

Standard Bins for LP379THR1-C0G (I_F = 70 mA)

Lamps are sorted to luminous flux (Φ_v), V_F and dominant wavelength (λ_D) bins shown.

Orders for LP379THR1-C0G may be filled with any or all bins contained as below.

All luminous flux (Φ_v), V_F and dominant wavelength (λ_D) values shown and specified are at I_F = 70 mA.

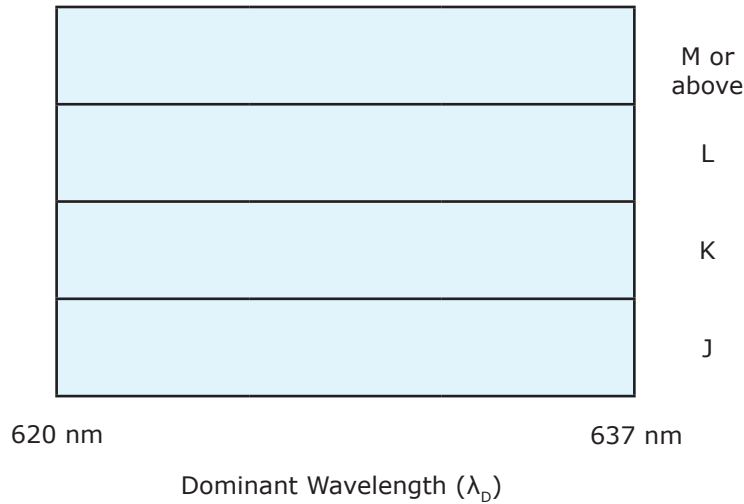

Rank	J	K	L
Luminous Flux	3000-4200 mlm	3500-4800 mlm	4000-6100 mlm

Forward Voltage (V_F)

Rank	V4	V5	V6	V7	V8
Voltage	2.2-2.4 V	2.4-2.6 V	2.6-2.8 V	2.8-3.0 V	3.0-3.2 V

Important Notes:

1. All ranks will be included per delivery; rank ratio will be based on the dice distribution.
2. No tolerance of measurement of luminous flux.
3. Tolerance of measurement of dominant wavelength is ±1 nm.
4. Tolerance of measurement of V_F is ±0.05 V.
5. Packaging methods are available for selection; please refer to the "Cree LED Lamp Packaging Standard" document.
6. Please refer to the "Cree LED Lamp Reliability Test Standards" document for reliability test conditions.
7. Please refer to the "Cree LED Lamp Soldering & Handling" document for information about how to use this LED product safely.

Graphs

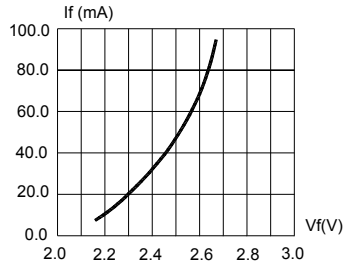

FIG.1 FORWARD CURRENT VS. FORWARD VOLTAGE.

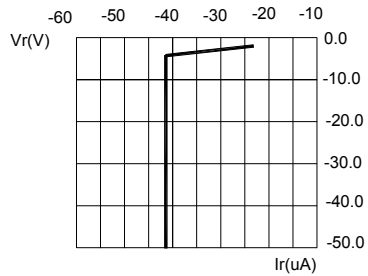

FIG.2 REVERSE CURRENT VS. REVERSE VOLTAGE.

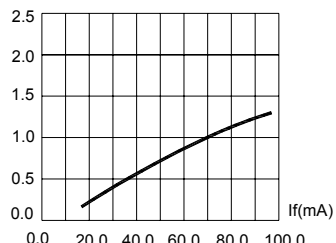

FIG.3 RELATIVE LUMINOUS FLUX VS. FORWARD CURRENT.

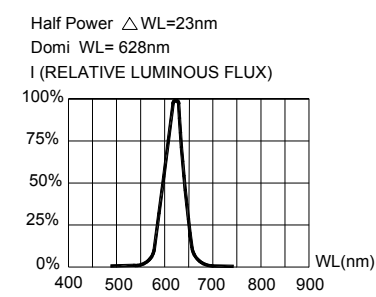

FIG.4 RELATIVE LUMINOUS FLUX VS. WAVELENGTH.

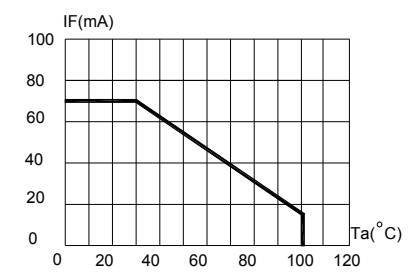

FIG.5 MAXIMUM FORWARD DC CURRENT VS AMBIENT TEMPERATURE (Tjmax=120 °C)

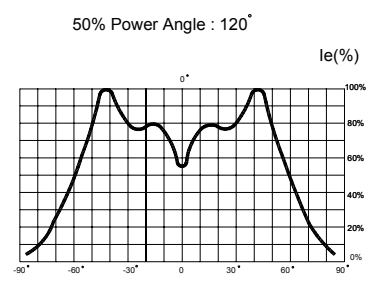

FIG.6 FAR FIELD PATTERN

Mechanical Dimensions

All dimensions are in mm. Tolerance is ± 0.25 mm unless otherwise noted.

An epoxy meniscus may extend about 1.5 mm down the leads.

Burr around bottom of epoxy may be 0.5 mm max.

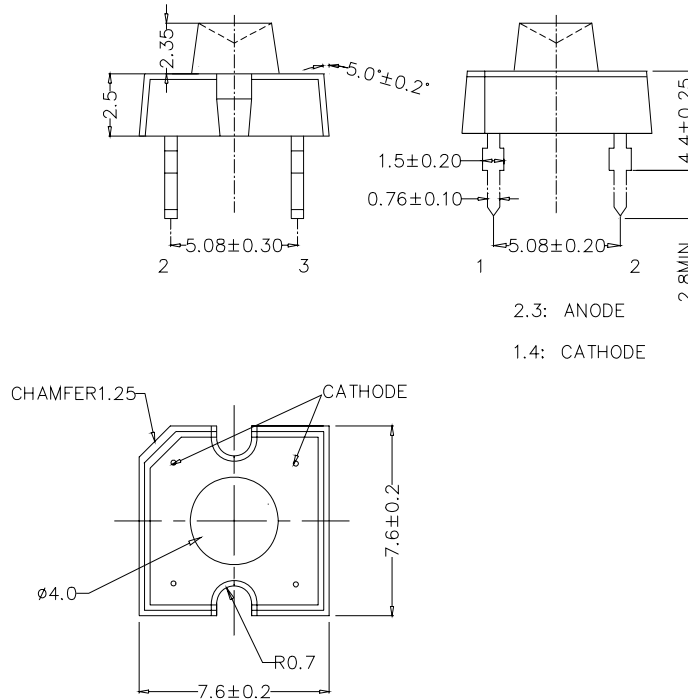

Notes

RoHS Compliance

The levels of environmentally sensitive, persistent biologically toxic (PBT), persistent organic pollutants (POP), or otherwise restricted materials in this product are below the maximum concentration values (also referred to as the threshold limits) permitted for such substances, or are used in an exempted application, in accordance with EU Directive 2002/95/EC on the restriction of the use of certain hazardous substances in electrical and electronic equipment (RoHS), as amended through April 21, 2006.

Vision Advisory Claim

Users should be cautioned not to stare at the light of this LED product. The bright light can damage the eye.

Kit Number System

Cree LED lamps are tested and sorted into performance bins. A bin is specified by ranges of color, forward voltage, and brightness. Sorted LEDs are packaged for shipping in various convenient options. Please refer to the "Cree LED Lamp Packaging Standard" document for more information about shipping and packaging options.

Cree LEDs are sold by order codes in combinations of bins called kits. Order codes are configured in the following manner:

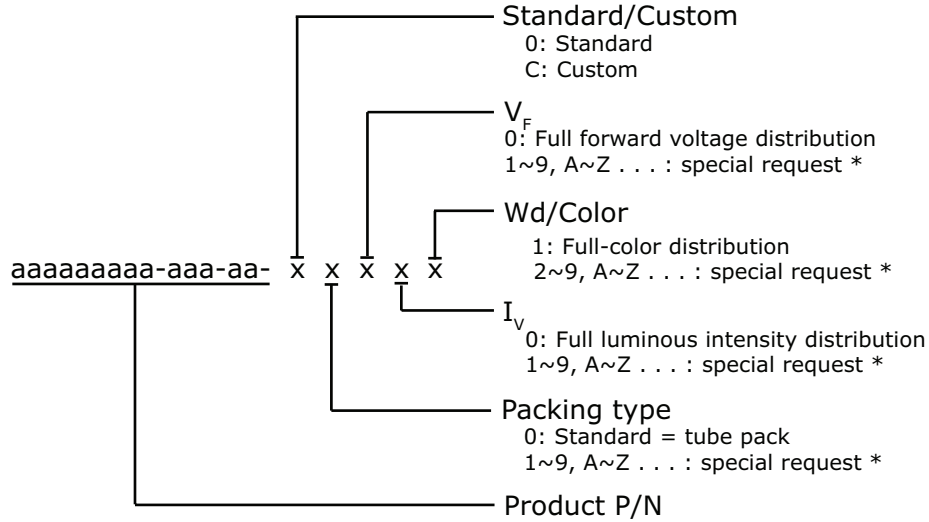

* Contact your Cree sales representative for ordering information.

Standard Available Kits*

Kit Number	Description
LP379THR1-COG-00001	P4 120 High Red 628nm, FULL RANK, Tube Pack
LP379THR1-COG-00011	P4 120 High Red 628nm, K or above, Tube Pack

* Please contact your Cree representative about the availability of non-standard kits.